

GREYSTONE

ACCURACY BY DESIGN

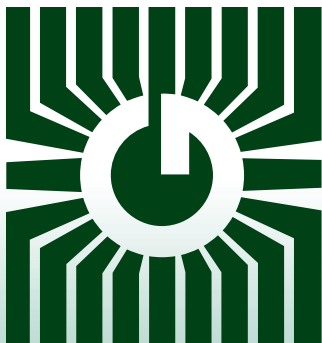

PRESSURE SWITCH AFS Series

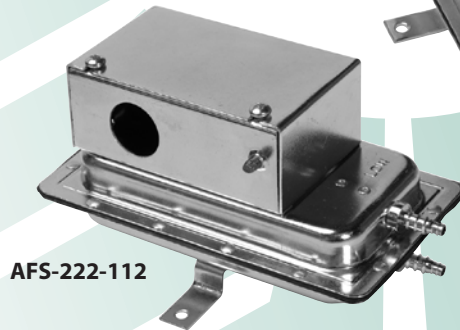

AFS-222-112

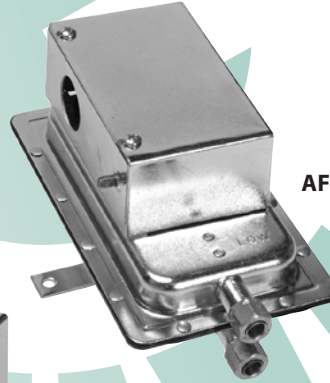

AFS-262

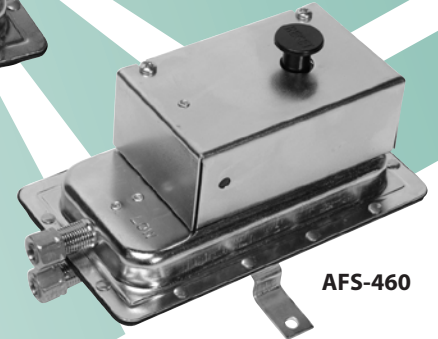

AFS-460

Precision pressure control/sensing

FEATURES:

- The plated housing contains a diaphragm, a calibration spring and a snap-acting SPDT switch.
- The sample connections located on each side of the diaphragm accept 6.35mm (0.25") OD tubing via the integral compression ferrule and nut or barbed fitting.
- An enclosure cover guards against accidental contact with the live switch terminal screws and the set point adjusting screw. The enclosure cover will accept a 12.7mm (0.5") conduit connection.
- Optional pressure ranges and manual resets available.

*Peace of mind
through reliable
pressure switches*

SPECIFICATIONS:

MODEL	AFS-222/AFS-222-112	AFS-262/AFS-262-112	AFS-460
Sample Media	Air	Air	Air
Mounting Position	Diaphragm in any vertical plane	Diaphragm in any vertical plane	Diaphragm in any vertical plane
Field Adjustable Range	0.05±, 0.02" w.c. to 12" w.c.	0.05±, 0.02" w.c. to 2" w.c.	0.40±, 0.06" w.c. to 12" w.c.
Switch Differential	Progressive, increasing from approx. 0.02± 0.01" w.c. at min. set point, to approx. 0.8" w.c. at max. set point	Progressive, increasing from 0.02± 0.01" w.c. at min. set point to approx. 0.1" w.c. at max. set point	Progressive, increasing from approx. 0.06± 0.01" w.c. at min. set point, to approx. 0.8" w.c. at max. set point
Maximum Pressure	0.5psi (0.03 bar)	0.5psi (0.03 bar)	0.5psi (0.03 bar)
Operating Temperature Range	-40°C - 82°C (-40°F - 180°F)	-40°C - 82°C (-40°F - 180°F)	-40°C - 82°C (-40°F - 180°F)
Life	100,000 cycles at 0.5psi max pressure each cycle and at max electrical load	100,000 cycles at 0.5psi max pressure each cycle and at max electrical load	6000 cycles at 0.5psi max pressure each cycle and at max. electrical load
Electrical Rating	300 va pilot duty at 115 - 277 VAC, 10 amp, non-inductive, 277 VAC, 60Hz	300 va pilot duty at 115 - 277 VAC, 10 amp, non-inductive, 277 VAC, 60Hz	300 va pilot duty at 115 - 277 VAC, 10 amp, non-inductive, 277 VAC, 60Hz
Contact Arrangement	SPDT	SPDT	SPST-NC
Electrical Connections	Screw top terminals with cup washers	Screw top terminals with cup washers	Screw top terminals with cup washers
Sample Line Connections	Ferrule and nut compression type connectors that accept 6.35mm (0.25") OD rigid tubing or 1/4" OD barbed connections (-112) that accept flexible tubing.	Ferrule and nut compression type connectors that accept 6.35mm (0.25") OD rigid tubing or 1/4" OD barbed connections (-112) that accept flexible tubing.	Ferrule and nut compression type connectors that accept 6.35mm (0.25") OD rigid tubing
Automatic/Manual Reset	Automatic	Automatic	Manual
Approvals	UL and CSA	UL and CSA	UL and CSA

Dimensions in millimeters and (inches)

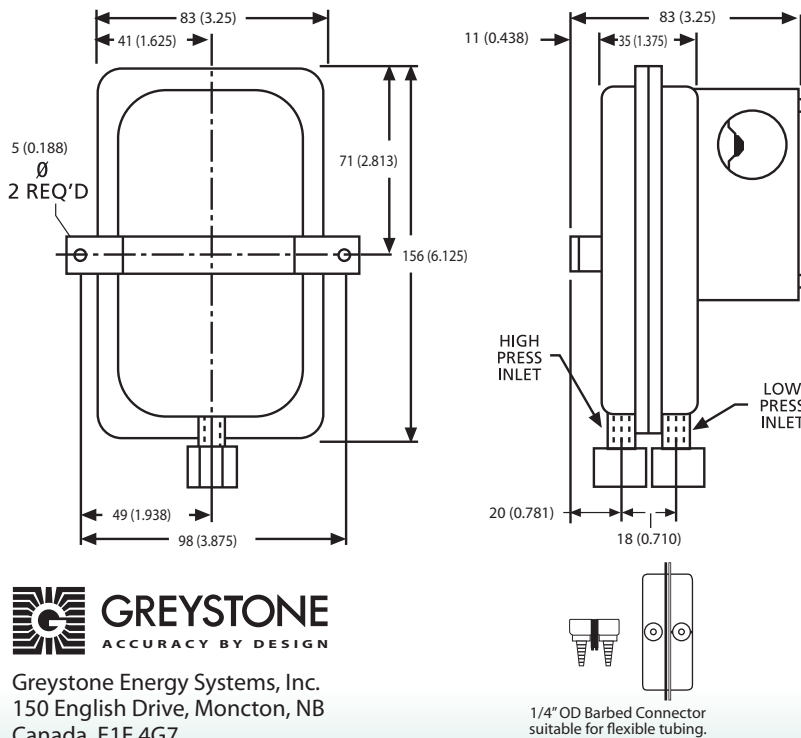

Alarm or Control

To prove excessive airflow or pressure

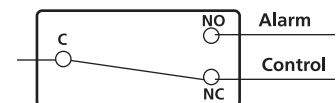

To prove insufficient airflow or pressure

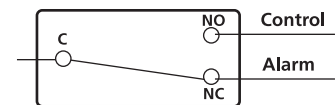

Greystone Energy Systems Inc. is one of North America's largest ISO registered manufacturers of HVAC sensors and transducers for Building Automation Management Systems.

We have conscientiously established a worldwide reputation as an industry leader by maintaining leading-edge design technology, prompt technical support, and a commitment to on-time deliveries. We take pride in our Quality Management System which is ISO 9001 certified, assuring our customers of consistent product reliability.

GREYSTONE HAS AN ISO 9001 REGISTERED QUALITY SYSTEM



Greystone Energy Systems, Inc.
150 English Drive, Moncton, NB
Canada E1E 4G7
(506) 853-3057 Fax: (506) 853-6014
North America: 1-800-561-5611
e-mail: mail@greystoneenergy.com
web site: www.greystoneenergy.com